



**SPIRIT** FITNESS  
A Heritage of Quality | The Spirit of Innovation

# Инструкция по сборке регулируемой скамьи для пресса



Руководство пользователя



A Heritage of Quality | The Spirit of Innovation  
**SPIRIT** FITNESS





A Heritage of Quality | The Spirit of Innovation  
**SPIRIT** FITNESS





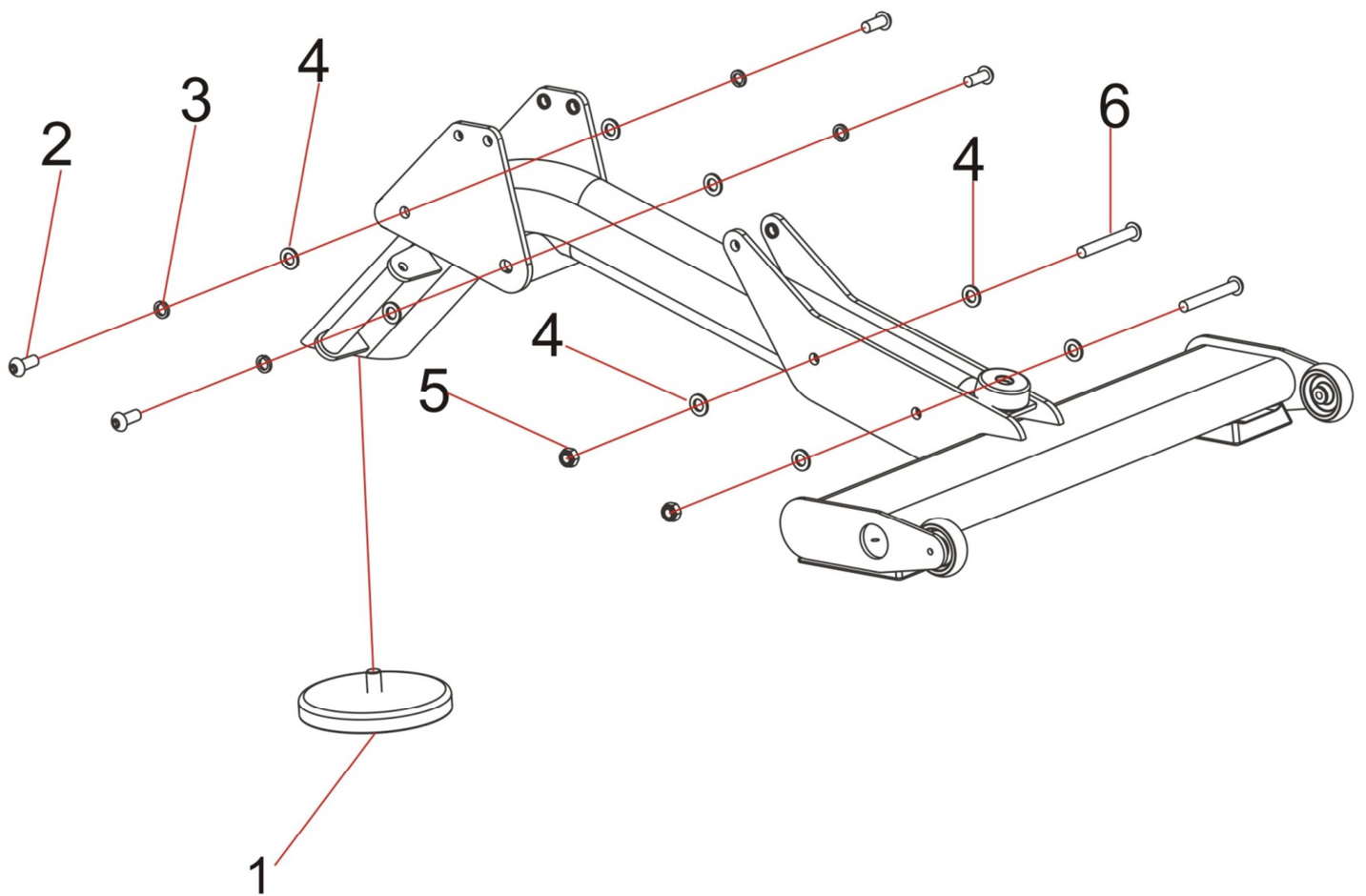

A Heritage of Quality | The Spirit of Innovation  
**SPIRIT** FITNESS

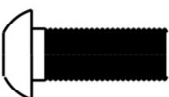

# 1







1  X1  
Φ 170X20

2  X4  
M12X30 

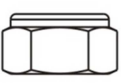
3  X4  
M12 

4  X8  
M12 

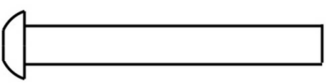
5  X2  
M12 

6  X2  
M12x90 

# 2

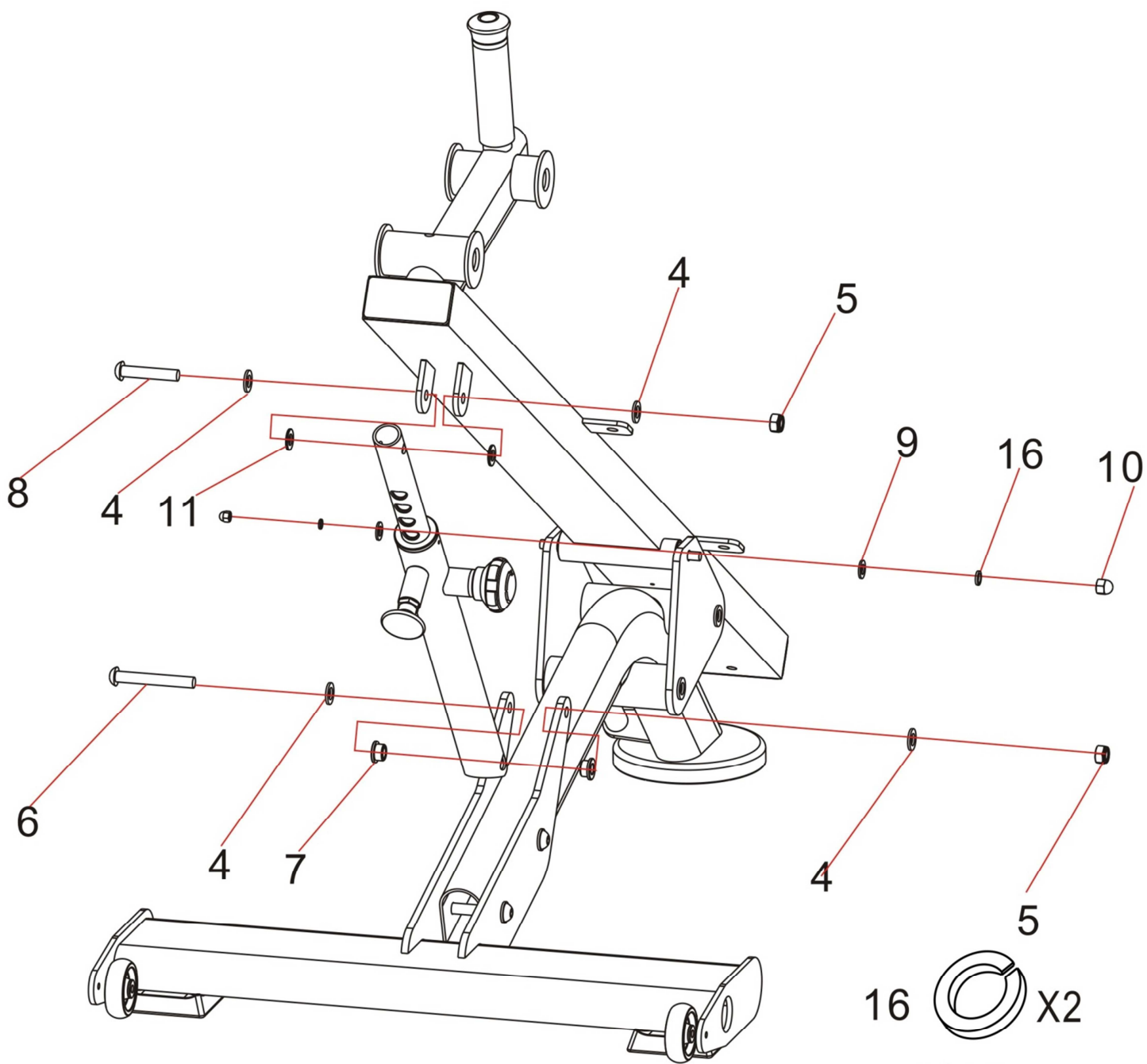

16  X2

M10 

4  X2

M12 

5  X1

M12 

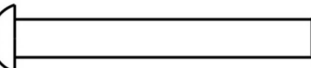
6  X1

M12x90 

7  X2

$\Phi 24 * \Phi 12 * 12$

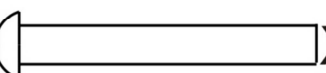
8  X1

M12x65 

9  X2

M10 

10  X2

M10 

11  X2

M12X2

# 3

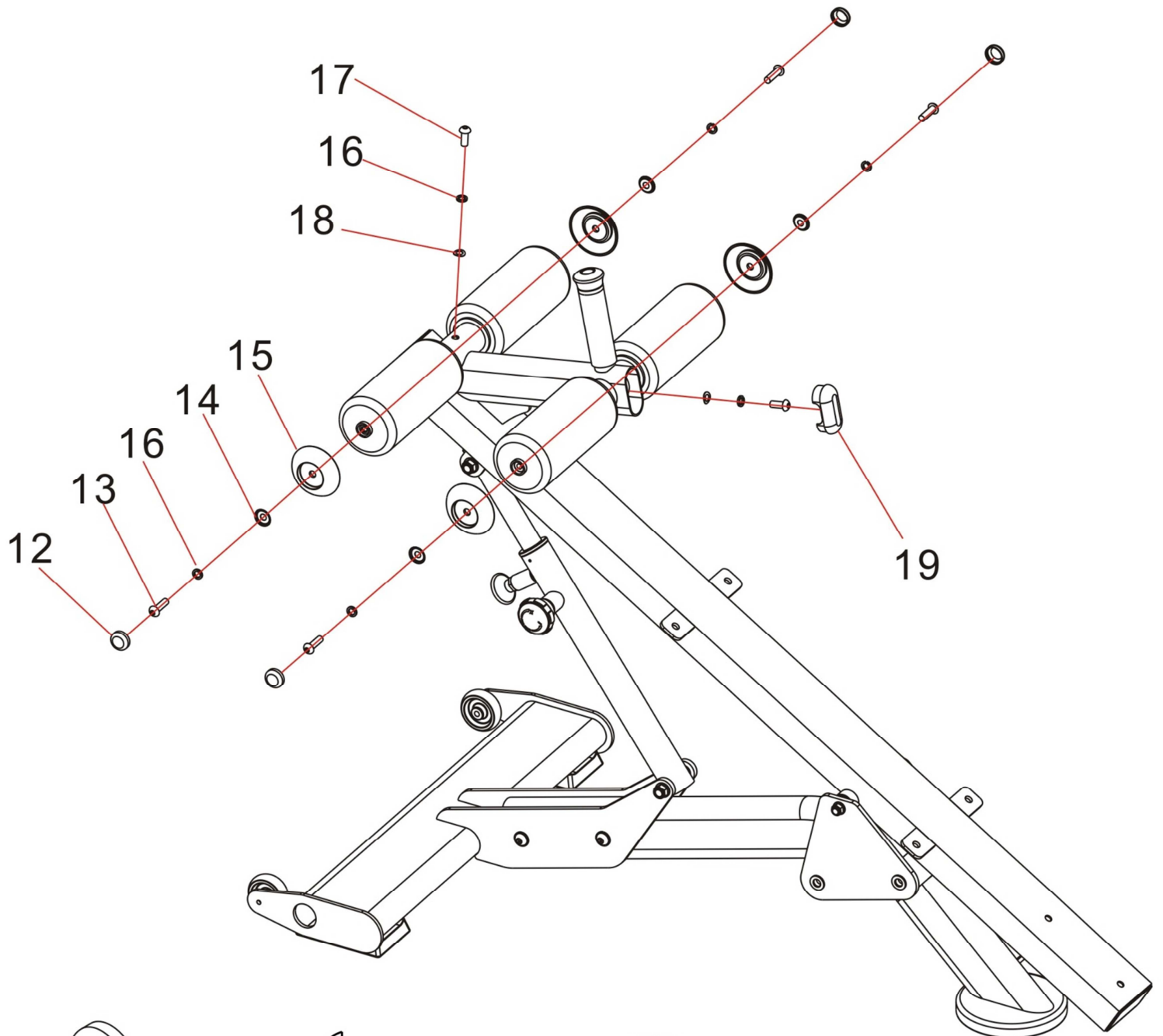



12  X4  
 $\Phi 30 \times 10$

13  X4  
M10X35

14  X2  
M10

18  X2  
M10

15  X4  
 $\Phi 85 \times 18$



16  X6  
M10

17  X2  
M10X25

19  X1  
PT40X80X2

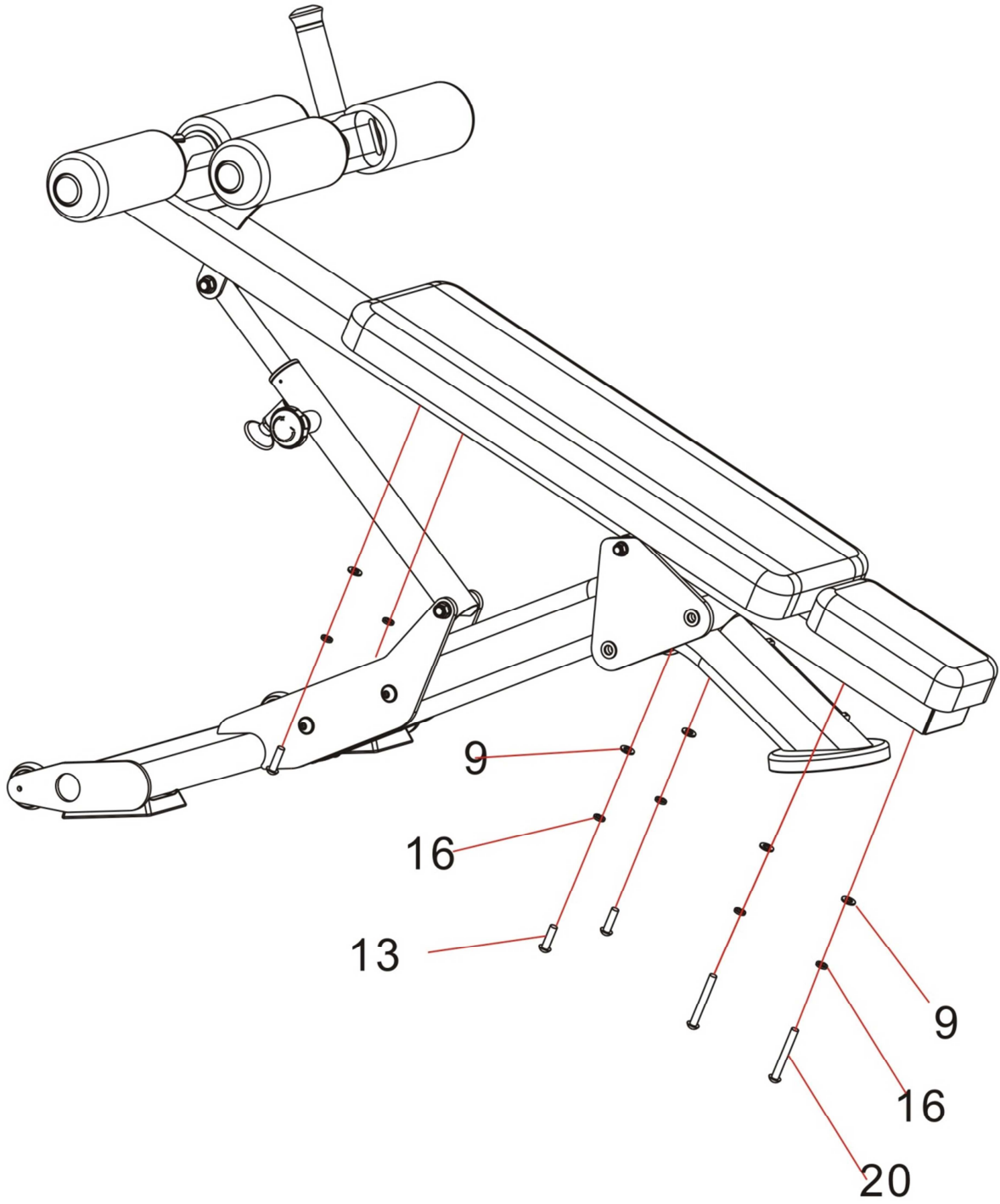
# 4

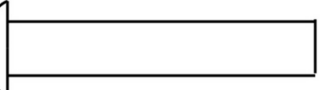

- |   |   |    |        |   |     |    |   |    |        |   |    |
|---|---|----|--------|---|-----|----|---|----|--------|---|----|
| 9 |  | X6 | 13     |  | X4  | 16 |  | X6 | 20     |  | X2 |
|   | M10   |    | M10X35 |   | M10 |    | M10   |    | M10X80 |   |    |

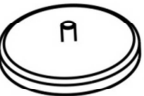
1  X1  
Φ170X20

2  X4  
M12X30

3  X4  
M12

4  X10  
M12

5  X3  
M12

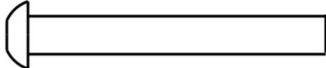
6  X3  
M12x90

7  X2  
Φ24\*Φ12\*12

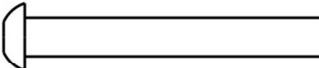
8  X1  
M12x65

9  X8  
M10

10  X2  
M10

11  X2  
M12X2

12  X4  
Φ30\*10

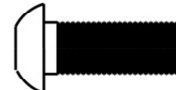
13  X8  
M10X35

14  X2  
M10

18  X2  
M10

15  X4  
Φ85\*18

16  X14  
M10

17  X2  
M10X25

19  X1  
PT40X80X2

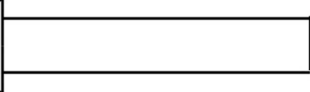
20  X2  
M10X80